



Everything for cleaning in the agriculture

easyfarm365+

easyfarm365+ . everything for cleaning in the agriculture

easyfarm365+

Everything for the professional cot and machine cleaning!

True to the motto: Your requirements are our strengths!

Our new product line **easyfarm365+** is especially designed for applications in the agriculture where high flow rates with ultra high pressures at the same time are used.

The high-quality spray device is characterized by ergonomic handling, high flexibility regarding its use by means of the largely dimensioned quick coupling system KW and by a convincing durability.



Professional gun with coupling ST-3100. Max. 250 bar / 60 l/min / 150 °C

R+M Nr.			
202 620 655		coupling KW	1/2" F swivel

Grips	Protector ST-10	Seal kits	ST-340 swivels	Nipples
Grip for lances with moulded handle	Grip for ST-85 Push & Pull lances	1/4" F. Nozzle protector. Plastic. Stain. steel	1/4" F : 1/2" F	Repair kit ST-340
M22 M : 1/2" M. Brass				
R+M Nr.	R+M Nr.	R+M Nr.	R+M Nr.	R+M Nr.
200 009 700	200 009 680	200 010 760	200 620 490	200 340 520
				200 340 150
				565 60

ST-85 Push & Pull lances

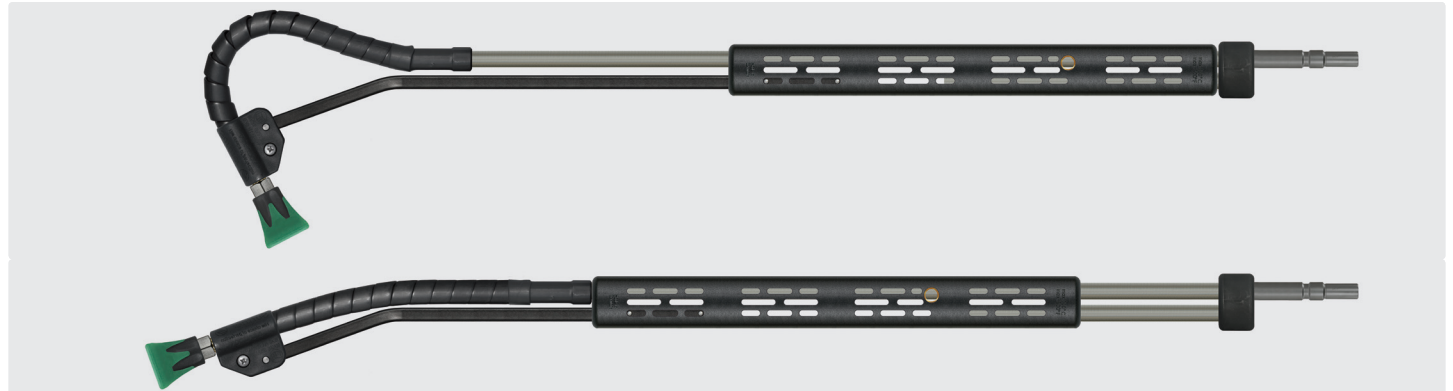

Plug KW. Lance stainless steel, vented handle ST-9 380 mm and nozzle protector ST-10 without nozzle. Variable adjustment of spraying angle from 20 to 140°. Especially designed for cleaning of places which are difficult to access. Max. 210 bar / 150 °C

R+M Nr.			
200 085 253	1/4" F NPT	600 mm	plug KW
200 085 613	1/4" F NPT	850 mm	plug KW
200 085 603	1/4" F NPT	1000 mm	plug KW
200 085 653	1/4" F NPT	1500 mm	plug KW

Lances



Plug KW. Lance stainless steel, moulded handle 400 mm and nozzle protector ST-10 without nozzle. Max. 400 bar / 150 °C

R+M Nr.			
200 000 522	400 mm	1/4" F NPT	1000 mm
			plug KW

easyfarm365+ . everything for cleaning in the agriculture

easyfarm365+

Lances



Plug KW. Lance stainless steel, moulded handle 300 mm, valve ST-54 aside and nozzle protector ST-10 with low pressure nozzle & thread 1/4" F. Max. 310 bar / 150 °C

R+M Nr.	ISO	☺	↔	☻
200 054 507	300 mm	1/4" F NPT	980 mm	plug KW



Plug KW. Lance stainless steel, moulded handle 400 mm and 1/4" M thread for rotating nozzles. Lance without rotating nozzle. Max. 400 bar / 150 °C

R+M Nr.	ISO	☺	↔	☻
200 000 523	400 mm	1/4" M	1000 mm	plug KW



Plug KW. Lance stainless steel, moulded handle 300 mm, valve ST-53 on top, nozzle protector ST-10 with low pressure nozzle and 1/4" M thread for rotating nozzles. Lance without rotating nozzle. Max. 250 bar / 150 °C

R+M Nr.	ISO	☺	↔	☻
200 053 538	300 mm	1/4" M	980 mm	plug KW



Plug KW. Foam lance stainless steel, vented handle ST-9.1, grip aside, integrated air injector (2,3 mm) and nozzle head with nozzle 50° 120. Only works with an additional chemical injector 200 160 500.

R+M Nr.	☺	↔	☻
200 072 566	nozzle 50° 120	500 mm	plug KW

Symbols ☺ outlet ☻ inlet ↔ length ISO insulation

easyfarm365+ . everything for cleaning in the agriculture

Suttner spray guns

ST-1200 spray guns



Spray gun with adjustable spray angle. Trigger guard. Max. 24 bar / 100 l/min / 50 °C

R+M Nr.	(M)	(C)
201 200 535	brass	1/2" F



Spray gun with adjustable spray angle. Trigger guard. Max. 24 bar / 100 l/min / 95 °C

R+M Nr.	(M)	(C)
201 200 550	stainless steel	1/2" F



Spray gun with adjustable spray angle. Max. 24 bar / 100 l/min / 50 °C

R+M Nr.	(M)	(C)
201 200 500	brass	1/2" F



Spray gun with adjustable spray angle. Max. 24 bar / 100 l/min / 50 °C

R+M Nr.	(M)	(C)
201 200 520	stainless steel	1/2" F

Repair kits ST-1200



R+M Nr.	(M)
201 200 420	stainless steel

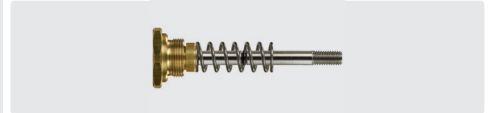

R+M Nr.	(M)
201 200 430	brass

Rotating nozzles ST-49.1



ST-49.1 without centric hole. 3/8" F. Ø 24 mm

R+M Nr.	(D)
200 049 891	08
200 049 892	10
200 049 893	12
200 049 894	15
200 049 895	20

High pressure hoses

GOLDEN-A

- » Very abrasion-resistant plastic coating.
- » Ideal for cleaning applications on rough floors which must be very non-abrasive.
- » Compact hose with 2 brazen wire braids.
- » Interior and Surface made out of synthetic rubber.
- » Particularly abrasion-, oil-, ozone-resistant and weatherproof.
- » Considerably increased durability compared to usual high pressure hoses.

Stainless Steel

3/8" : 3/8" 1/2" : 1/2"

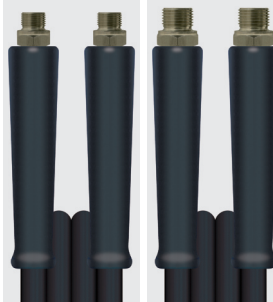

Standard

- » Field of application: suitable for versatile, universal applications such as industrial plants, agriculture, petrol stations etc.
- » Interior made out of synthetic rubber. Very temperature-resistant.
- » Resistant to usual washing agents.
- » Hose with double wire braid.
- » Surface made out of synthetic rubber.
- » Abrasion-, oil-, ozone-resistant and weatherproof.

Steel zinc plat

3/8" : 3/8" 1/2" : 1/2"



TYP	DN	P	BP	°C	↔
2SC	10	375 bar	>1500 bar	100 °C	10 m
					20 m
					25 m
					30 m
					40 m
2SC	12	310 bar	>1240 bar	100 °C	10 m
					20 m
					25 m
					30 m
					40 m
					50 m

R+M Nr.	R+M Nr.
355 544 310 9	
355 544 320 9	
355 544 325 9	
355 544 330 9	
355 544 340 9	
355 544 350 9	
	365 546 310 9
	365 546 320 9
	365 546 325 9
	365 546 330 9
	365 546 340 9
	365 546 350 9

TYP	DN	P	BP	°C	↔
2SC	10	400 bar	>1500 bar	150 °C	10 m
					20 m
					25 m
					30 m
					40 m
2SC	12	300 bar	>1200 bar	150 °C	10 m
					20 m
					25 m
					30 m
					40 m
					50 m

R+M Nr.	R+M Nr.
355 144 310	
355 144 320	
355 144 325	
355 144 330	
355 144 340	
355 144 350	
	365 146 310
	365 146 320
	365 146 325
	365 146 330
	365 146 340
	365 146 350

Symbols (M) material (DN) nominal diameter (P) pressure (BP) burst pressure (D) nozzle (C) colour (I) height (↔) length (C) Inlet (O) outlet (B) weight

easyfarm365+ . everything for cleaning in the agriculture

High pressure hose reels STKI

The STKI series suitable for applications in craft and industry:

- » The base frame is made out of canted steel sheet profiles which stand for excellent stability.
- » The drum rotates by means of an adjustable handwheel being equipped with a free-wheel polyamide grip.
- » By means of a mechanical brake integrated in the bearing the drum can be slowly decelerated or even totally blocked.

» Suitable for the mediums water or water with cleaning detergent, air, oils and greases.

» The hose reels are all equipped with a swivel ST-322. The swivels ST-322 are completely made out of stainless steel and have a ring as sealing element.

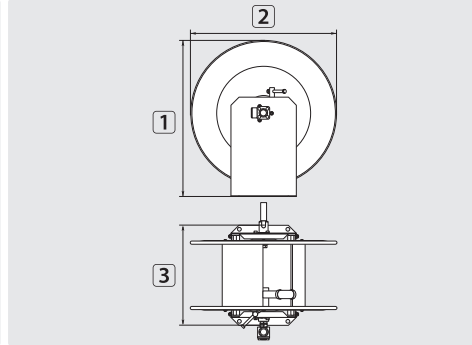

TYP	outer \varnothing = hose \leftrightarrow
01	22,0 mm = 35 m
02	22,0 mm = 70 m
03	22,0 mm = 100 m
04	22,0 mm = 115 m

Stainless steel V2A / AISI 304

R+M Nr.	C	⊖	DN	P	°C	⊘	1	2	3	TYP
739 50	1/2" F	1/2" F	12	300 bar	100 °C	10,5 kg	515 mm	465 mm	312 mm	01
739 60	1/2" F	1/2" F	12	300 bar	100 °C	13,5 kg	515 mm	465 mm	512 mm	02
739 65	1/2" F	1/2" F	12	300 bar	100 °C	15,7 kg	515 mm	465 mm	712 mm	03
739 701 2	1/2" F	1/2" F	12	300 bar	100 °C	16,8 kg	515 mm	465 mm	812 mm	04

Trolleys STKI



Trolley suitable for types 01 / 02 / 05 / 06. Grey solid rubber tyres. Suitable for the food industry

R+M Nr.	M
739 000	stainless steel V2A / AISI 304

Accessories for high pressure hose reels



1/2" F : 1/2" M. NW 12.
Max. 300 bar / 90 °C

1/2" F : 1/2" M. NW 12.
Max. 300 bar / 90 °C

R+M Nr.	I
200 322 520	67 mm

R+M Nr.	I
200 322 522	68 mm

Stainless steel drums suitable for longer lengths are available on request.

Suction set with suction filter ST-31



R+M Nr.	TYP	C	↔
731 12	without valve *	ÜM 3/4" F	3 m
731 21	with valve *	ÜM 3/4" F	3 m

* check valve ** housing black

Suttner rotating nozzles

ST-458.1



1/4" IG. Spray angle 20°.
200 - 400 bar. Max. 100 °C

R+M Nr.	D	C *
200 458 665	065	nature
200 458 670	07	pink
200 458 680	08	orange
200 458 690	09	green
200 458 610	10	grey

ST-458.1



Kit ST-458.1

R+M Nr.
200 458 265
200 458 270
200 458 280
200 458 290
200 458 210



1/4" IG. Spray angle 20°.
120 - 250 bar. Max. 100 °C

R+M Nr.	D	C *
200 458 811	11	
200 458 812	12	
200 458 815	15	
200 458 820	20	
200 458 825	25	
200 458 830	30	

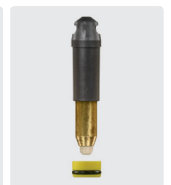

Kit ST-458.1

R+M Nr.
200 458 311
200 458 312
200 458 315
200 458 320
200 458 325
200 458 330

Foam injector lances easyfoamer ST-73



1/4" F. Lance with regulator and bottle. Max. 250 bar / 80 °C

R+M Nr.	D	📦
200 073 500	1,25	1 l
200 073 510	1,25	2 l
200 073 610	1,80	2 l

There has been an addition to the family of foam injectors!

By matching max. 250 bar and 80 °C the new easyfoamer ST-73 belongs to the injector lances of the future.

The stainless steel injector which is especially resistant to chemicals realizes an ideal mixing of air and cleaning agent, thus succeeding an ideal foam result.

In order to achieve a nearly identical and comparable result, there are five defined dosing positions available.

There are a 1 l and a 2 l bottle available - the length of the suction hose is the same. Due to cross knurling at the bottom the bottle can be easily opened and changed.

Bottle

Bottle for ST-70 / ST-73



R+M Nr.	📦
020 073 513	1 l
020 073 520	2 l

Cover



Cover for ST-70 / ST-73

R+M Nr.
020 073 522

Foam pad

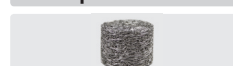

R+M Nr.
540 500 09



M22 F. Lance with regulator and bottle. Max. 250 bar / 80 °C

R+M Nr.	D	📦
200 073 516	1,25	1 l
200 073 518	1,25	2 l
200 073 618	1,80	2 l



M22 F swivel. Lance with regulator and bottle. Max. 250 bar / 80 °C

R+M Nr.	D	📦
200 073 520	1,25	1 l
200 073 522	1,25	2 l
200 073 622	1,80	2 l



M22 M. Lance with regulator and bottle. Max. 250 bar / 80 °C

R+M Nr.	D	📦
200 073 512	1,25	1 l
200 073 514	1,25	2 l
200 073 614	1,80	2 l



Plug KW. Lance with regulator and bottle. Max. 250 bar / 80 °C

R+M Nr.	D	📦
200 073 528	1,25	1 l
200 073 530	1,25	2 l
200 073 630	1,80	2 l

easyfarm365+ . everything for cleaning in the agriculture

Sprayer

Industry Line



The sprayer of the series Industry line are special devices for extraordinary difficult applications such as car wash, oil platforms or industrial cleaning applications.

They are resistant to lots of chemicals which are used in industry.

Due to the acid-resistant lance, the viton seals and the extremely durable high-pressure container the devices are designed for the most difficult cleaning applications. Safety for the user is absolutely guaranteed.

Field of application

- » Oil industry
- » Chemical industry
- » Control of epidemics
- » Workshops and factories
- » Disinfection and rat control

R+M Nr.					VPE
106 995 070	2,0 kg	470 mm	220 mm	7 l	1/4
106 995 090	2,2 kg	570 mm	220 mm	9 l	1/4
106 995 120	2,4 kg	600 mm	220 mm	12 l	1/4

Spare parts Industry Line



Telescopic lance with handle 700 - 1350 mm

R+M Nr.
106 995 500



Nozzle 1,5 mm

R+M Nr.
106 995 502



Hose 1,7 m

R+M Nr.
106 995 501



Seal kit

R+M Nr.
106 995 503

Foam gun



Applications

Designed for applications with acidic and caustic cleaner, soaps, disinfectants, degreasing and softening agents. The field of application is very versatile.

- » Food industry and canteen kitchen
- » Sanitary facilities and swimming baths
- » Cleaning of trucks, cars and other vehicles
- » Garages and petrol stations
- » Shops and workshops

The foam gun directly connected to the public water pipe produces a cleaning foam by means of foam injector. The water pressure sucks in the cleaning agent and air, both are being mixed to consistent foam, sprayed out via the spraying head and the foam wand. The cleaning agent can also purposely and automatically be diluted via a built-in proportioner so that the right mixture of chemical and water as foam can be chosen for the cleaning application.

Technical specifications

Water pressure 2,5 - 6 bar (for maximum accuracy 3 - 4 bar)

Output 5,5 l/min

Mixing Ratio

Multi-ratio dial has 5 mixing settings and off

A	B	C	D	E	0
1:128	1:64	1:32	1:20	1:10	off

R+M Nr.		
106 996 500	3/4" F	1 l
106 996 510	3/4" F	2 l



Features

- » Exceptional chemical resistance to acidic and caustic cleaner
- » Foam generating wand creates a thick clinging foam
- » Automatic dosing of chemicals
- » Durable polymer mixing head with stainless steel screws
- » Multi-ratio dial has 5 mixing settings and off
- » Anti-siphon built into handle
- » Gun is removable from quick coupling for clear rinsing with water
- » Easy filling by means of wide mouth
- » Only works with water pipe pressure
- » Suitable for all customary water couplings

Please use the backflow preventer (R+M Nr. 734 10) on page 22 in the R+M / Katalog 2012-13

easyfarm365+ . everything for cleaning in the agriculture

Sprayer with pressure tank



- » The filling is very easy and effected by means of a plastic hopper to fill in.
- » 1/4" M connection to be attached at the compressed-air supply.
- » Max. 8 bar. Equipped with a default safety valve.
- » Chemically resistant hose 10 m. Spray lance 600 mm with nozzle. Fill level indication.
- » Suitable for the use in the food industry, car wash and industry.

Foamer with pressure tank

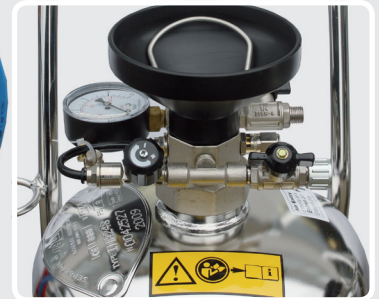

- » The filling is very easy and effected by means of a plastic hopper to fill in.
- » 1/4" M connection to be attached at the compressed-air supply.
- » Max. 8 bar. Equipped with a default safety valve.
- » Chemically resistant hose 10 m. Spray lance 600 mm with nozzle. Fill level indication.
- » Integrated dosing unit to realise the desired air/foam mixture. Permanent pressure exposure is required in order to achieve an uniform foam result.
- » Suitable for the use in the food industry, car wash and industry.

R+M Nr.	TYP	📏
106 024 600	stainless steel AISI 304, V2A	24 l
106 050 600	stainless steel AISI 304, V2A	50 l

R+M Nr.	TYP	📏
106 024 650	stainless steel AISI 304, V2A	24 l
106 050 650	stainless steel AISI 304, V2A	50 l

Suitable for keeping and application of liquids of group 2 according to the directive EWG/67/548 Art. 2, para. 2 and directive EG/97/23 Art. 9. Not suitable for liquids of group 1.

Chemical spray guns & lances

Chemical spray guns with lance

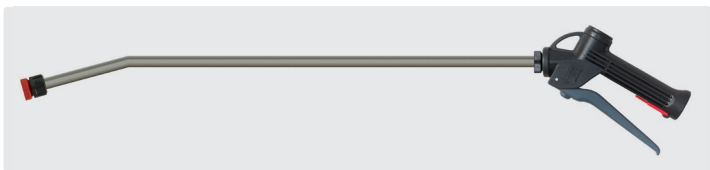

Gun with stain. steel V4A / AISI 316 ball being resistant to chemicals. Lance stain. steel with nut for nozzle without nozzle. Max. 25 bar / 30 l/min / 50 °C

R+M Nr.	🔧	📏
106 920 60	1/2" F	600 mm

Chemical spray guns with lance



Gun with stain. steel V2A / AISI 304 ball being resistant to chemicals. Lance plastic with nut for nozzle without nozzle. Max. 25 bar / 30 l/min / 50 °C

R+M Nr.	🔧	📏
500 016 000	1/2" F	600 mm

Chemical spray guns



Gun with stainless steel V4A / AISI 316 ball being resistant to chemicals. Max. 25 bar / 70 l/min / 50 °C

R+M Nr.	🔧	🔧
500 00	1/2" F	1/2" F

Filter



Plastic. Max. 50 °C

R+M Nr.
500 04

Chemical spray guns with lance

















Gun with stain. steel V2A / AISI 304 ball being resistant to chemicals. Lance plastic with nut for nozzle without nozzle. Max. 25 bar / 30 l/min / 50 °C

R+M Nr.	🔧	📏
500 012 100	1/2" F	210 mm

easyfarm365+ . everything for cleaning in the agriculture

Accessories for sprayer and foamer

Foam hoses		Spray hoses		Nut for nozzle	Seals	Nozzle 60° 25	Nozzle 100° 03	
								
R+M Nr.   10 m		R+M Nr.   1/4" M 10 m		1/2" M R+M Nr. 106 909 3	R+M Nr. 106 909 4	Foamer R+M Nr. 609 802 59	Sprayer R+M Nr. 609 110 03	
106 901 01 bayonet		106 911 01 1/4" M						
Nozzle filters		Reduction nipples		Adaptor				
								
50 MESH R+M Nr. 106 909 2		1/4" F : 1/2" M. Brass R+M Nr. 575 40		1/4" F : 1/2" M. Stainless steel R+M Nr. 575 49		Bayonet : 1/4" M R+M Nr. 106 900 1		Plug DN 7,4 : 1/4" F R+M Nr. 554 714



Mud suckers

The high-performance mud sucker for all standard pressure washers

extracts stones (up to 20 mm), mud, dirt, sand, algae & sediment.
Operating pressure min. 80 bar at 7 l/min. Suction power of approx. 8,000 to 18,000 l/h. Spiral hose: DN 38 mm, length 5 m



Performance chart

high pressure cleaner		capacity of mud sucker	
		capacity	capacity
100 bar	10 l/min	ca. 170 l/min	ca. 10 000 l/h
150 bar	12 l/min	ca. 220 l/min	ca. 13 000 l/h
200 bar	15 l/min	ca. 300 l/min	ca. 18 000 l/h



	M22 M	M21 M	1/2" M	M18 M
	R+M Nr.	R+M Nr.	R+M Nr.	R+M Nr.
04	545 504 0	545 514 0	545 524 0	545 534 0
045	545 504 5	545 514 5	545 524 5	545 534 5
05	545 505 0	545 515 0	545 525 0	545 535 0
055	545 505 5	545 515 5	545 525 5	545 535 5
06	545 506 0	545 516 0	545 526 0	545 536 0
065	545 506 5	545 516 5	545 526 5	545 536 5
07	545 507 0	545 517 0	545 527 0	545 537 0
08	545 508 0	545 518 0	545 528 0	545 538 0

Symbols  outlet  Inlet  length  thread  pressure  flow  type  volume

easyfarm365+ . everything for cleaning in the agriculture

High pressure telescopic lances

- » Light and handy. Length easily adjustable. Adjustable from 2.3 m to 7.4 m.
- » Lance with embedded high pressure hose and mounted Suttner gun ST-601. Lance without high pressure nozzle.
- » Max. 275 bar / 100 °C

Our telescopic high pressure lances are up to 30 % lighter than comparable lances.

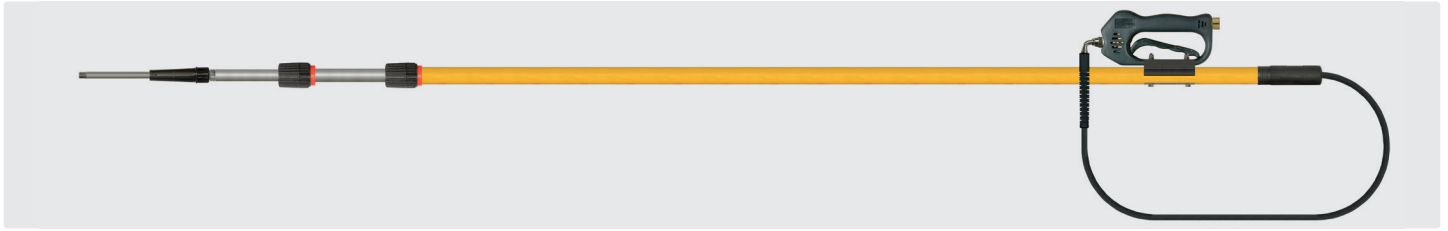

R+M Nr.	⊞	(R)	⊖	↔	⊕
525 070 5	2,9 kg	lance straight	1/4" M	2,3 - 3,8 m	3/8" F
525 085 5	3,3 kg	lance straight	1/4" M	2,3 - 5,6 m	3/8" F
525 100 5	3,9 kg	lance straight	1/4" M	2,9 - 7,4 m	3/8" F

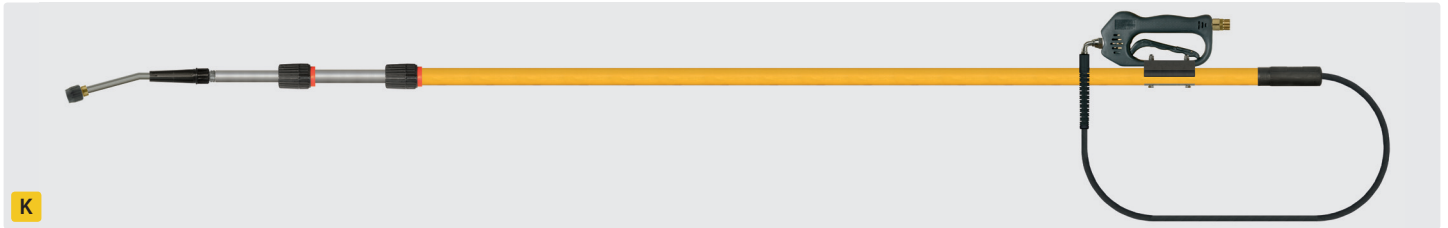

K

R+M Nr.	⊞	(R)	⊖	↔	⊕
525 070 1	3,0 kg	lance 15° bended	nozzle protector without tip	2,3 - 3,8 m	M22 M
525 085 1	3,4 kg	lance 15° bended	nozzle protector without tip	2,3 - 5,6 m	M22 M
525 100 1	4,0 kg	lance 15° bended	nozzle protector without tip	2,9 - 7,4 m	M22 M

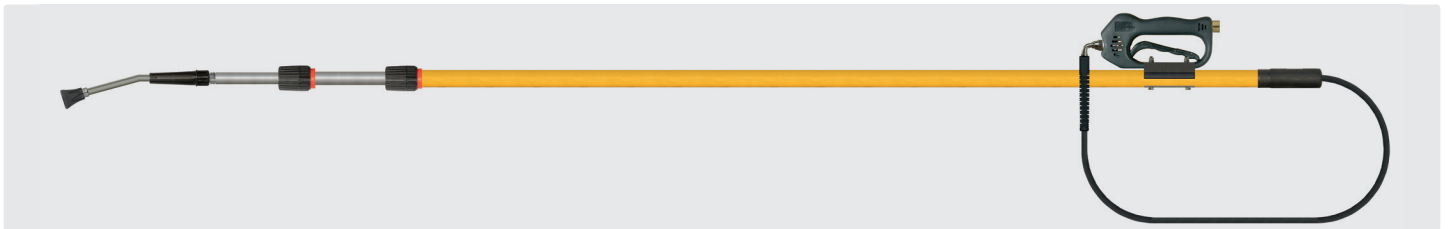

R+M Nr.	⊞	(R)	⊖	↔	⊕
525 070 2	2,9 kg	lance 15° bended	nozzle protector ST-10 - 1/4" F NPT	2,3 - 3,8 m	3/8" F
525 085 2	3,3 kg	lance 15° bended	nozzle protector ST-10 - 1/4" F NPT	2,3 - 5,6 m	3/8" F
525 100 2	3,9 kg	lance 15° bended	nozzle protector ST-10 - 1/4" F NPT	2,9 - 7,4 m	3/8" F



Screw connections



R+M Nr.
525 901

Wall cleaner

turbodevil



Adaptor



M22 F : 1/4" F

R+M Nr.
561 30

- » Rotating wall cleaner suitable for telescopic lances
- » Splash guard plastic
- » Splash guard ⊘ 320 mm
- » Without nozzles. 2 nozzles 1/4" M with 15° spray angle are required
- » Max. 150 bar / 60 °C. Flow 500 - 750 l/h

R+M Nr.	⊕	⊕
521 032 250	M22 M	2,4 kg

Symbols ⊖ outlet ⊕ Inlet ↔ length (M) material ⊞ weight (R) pipe

